



TN4S / TN4SA



TN4S-L



TACON



TACOL

CHARACTERISTICS

Plugs made of polyamide 6.

Recommended to be used with our countersunk screws, TPPO (Pz recess), TPTO (Tx recess) or TB coach wood screws.

Service temperature: -40 + 70 °C.

Use: Fixing of gates, railings, supports, shelves, signs, toilets, etc. both in hollow and solid materials.

INDIVIDUAL CHARACTERISTICS

TN4S/TN4SA/TN4S-L:

- Recommended either for solid base material (concrete, stone, solid bricks, etc.) or hollow base material (hollow bricks, concrete blocks, drywalls, etc.).
- Wide flared lip version(TN4SA) to keep the plug from sliding into the base material during the installation.
- Anti-spin side wings in order to fix it to any kind of base material.
- Expand in 4 directions
- Installation data marked on the plug itself: drill diameter, drill depth y screw diameter to use.

TACOL:

- Anti-spin side wings to prevent the plug from turning while the knot is forming.
- With flared lip, to keep the plug from sliding into the base material during the installation.
- Recommended mainly for solid base material (concrete, stone, solid brick, etc.).

TACON:

- Anti-spin side wings to prevent the plug from turning while the knot is forming.
- Recommended mainly for solid base material (concrete, stone, solid brick, etc.).

APPLICATION EXAMPLES

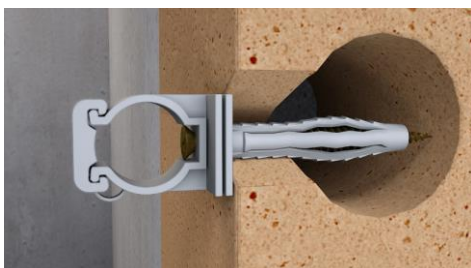

BASE MATERIAL SELECTION TABLE					
MATERIALS		TN4S / TN4SA	TN4S-L	TACOL	TACON
Concrete					
Stone					
Aerated concrete					
Drywall					
Solid brick					
Adobe brick					
Concrete block					
Hollow brick					
PERFORMANCES	High		Medium		

1. RANGE

ITEM	CODE	SIZE	PHOTO	MATERIAL
1	TN4S/TN4SA*	∅5 x 25 to ∅14 x 70		 Ny NYLON POLYAMIDE 6
2	TN4S-L	∅6 x 45 to ∅10 x 80		
3	TACOL	∅5 x 25 to ∅12 x 60		
4	TACON	∅4 x 20 to ∅16 x 80		

*TN4SA solo disponible en diámetro ∅6

2. INSTALLATION DATA

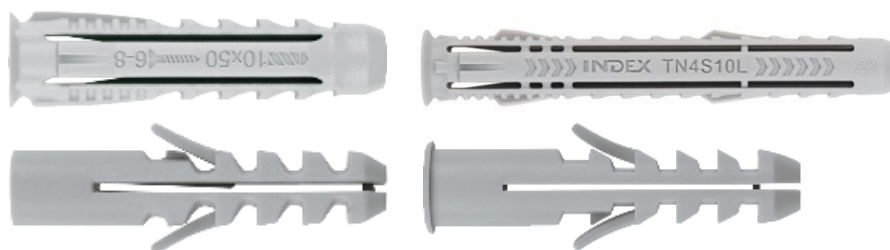

Installation data

CODE	Dimensions	d _o : drill diameter	h _{ef} = h _{nom} : effective depth	h ₁ : minimum drill hole depth	Recommended screw
	[mm]	[mm]	[mm]	[mm]	[--]
TN4S05	5x25	5	25	30	TPPO 2,5-4
TN4S06 / TN4SA06	6x30	6	30	40	TPPO 4-5
TN4S08	8x40	8	40	50	TPPO 4-6 TB 5-6
TN4S10	10x50	10	50	60	TB 6-8
TN4S12	12x60	12	60	70	TB 8-10
TN4S14	14x70	14	70	80	TB 10-12
TN4S06L	6 x 45	6	45	55	TPPO 4-5
TN4S08L	8 x 60	8	60	70	TPPO 4-6 / TB 5-6
TN4S10L	10 x 80	10	80	90	TB 6-8
TACON04	4X20	4	20	25	TPPO 2,5-3
TACON05 / TACOL05	5X25	5	25	35	TPPO 2,5-4
TACON06 / TACOL06	6X30	6	30	40	TPPO 3,5-4
TACOLA06	6X30	6	30	40	TPPO 3,5-4
TACON07	7X35	7	35	45	TPPO 4-4,5
TACON08 / TACOL08	8X40	8	40	50	TPPO 4,5 TB 5-6
TACON10 / TACOL10	10X50	10	50	60	TB 6-8
TACON12 / TACOL12	12X60	12	60	70	TB 8-10
TACON14	14X70	14	70	80	TB 10-12
TACON16	16X80	16	80	90	TB 12-14

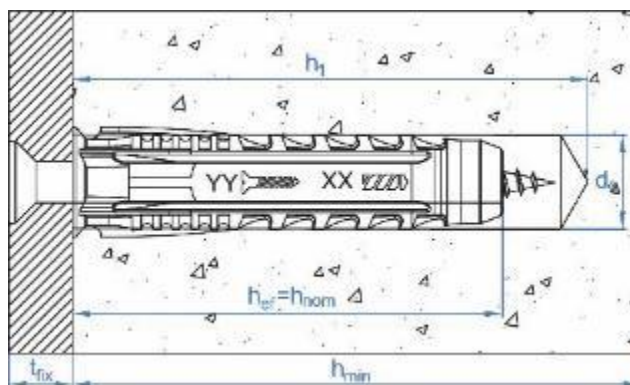

3. INSTALLATION PROCEDURE

3.1. Woodscrew installation

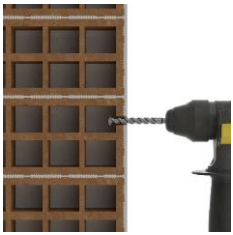

1. DRILL

Check concrete is well compacted and porosity insignificant.
 Drilling must be performed at the specified minimum depth and diameter in the previous table. Switch drill to hammer mode in case of drilling in concrete.
 In case of hollow materials do not use the hammer mode to avoid damaging the base material interior. Reduce drilling speed when we are about to finish the hole.
 Suitable for dry and wet drill holes.

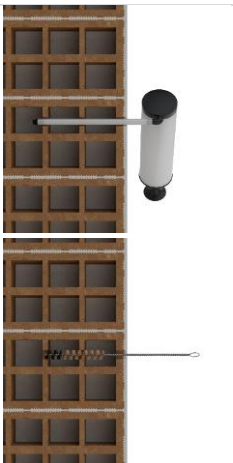

2. BLOW AND CLEAN

Clean hole of dust and debris.
 Use blow-pump and cleaning brushes.

3. INSTALL

Insert the plug through base material. Have to be done till the edge, in case of having flared lip

4. APPLY TORQUE

Screw the bolt without applying an excessive tightening torque that may cause the plug to become over threaded. This is important when it comes to hollow materials, because due to the expansion of the block requires a greater number of turns of the screws.

5. INFO TO BE CONSIDERED

- For screw diameter \varnothing selection apply this approximated rule*:

$$\varnothing_{\text{screw}} = \frac{\varnothing_{\text{plug}}}{2} + 1$$

- In order to select screw length apply this approximated rule:

$$\text{Screw length} = t_{\text{fix}} + L + 5\text{mm}^{**}$$

*Do not apply this rule from $\geq \varnothing 12\text{mm}$ to higher diameters

**Due to the peak angle of the screw

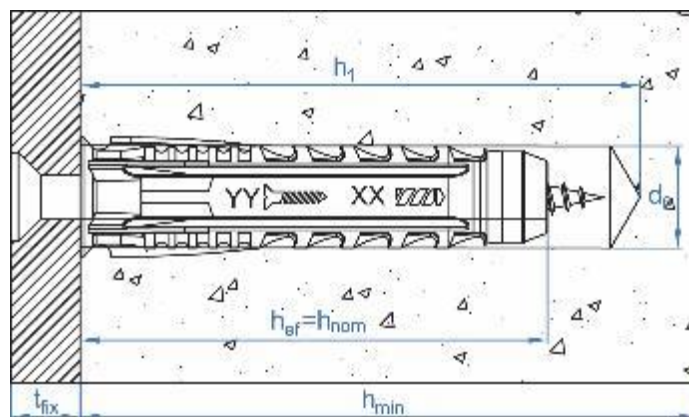

3.2. Threaded rod installation

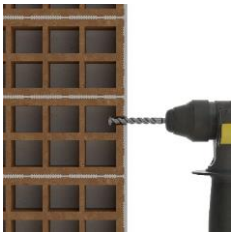

1. DRILL

Check concrete is well compacted and porosity insignificant.
 Drilling must be performed at the specified minimum depth and diameter in the previous table. Switch drill to hammer mode in case of drilling in concrete.
 In case of hollow materials do not use the hammer mode to avoid damaging the base material interior. Reduce drilling speed when we are about to finish the hole.
 Suitable for dry and wet drill holes.

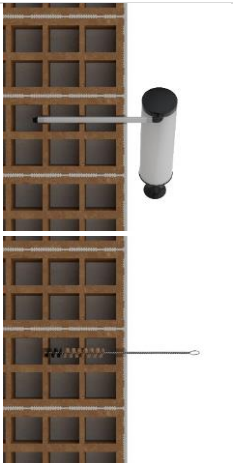

2. BLOW AND CLEAN

Clean hole of dust and debris.
 Use blow-pump and cleaning brushes.

3. INSTALL

Insert the plug through base material. Have to be done till the edge, in case of having flared lip

4. APPLY TORQUE

Screw the bolt without applying an excessive tightening torque that may cause the plug to become over threaded. This is important when it comes to hollow materials, because due to the expansion of the block requires a greater number of turns of the screws.



5. INFO TO BE CONSIDERED

- It is recommended to use woodscrews in order to perform correct installation. In case of using threaded rod, it is particularly recommended to do it at low revolutions and use the next metric and lengths for each nylon plug size:

PLUG	THREADED ROD	MINIMUM LENGTH [mm]
TN4S05	N/A	N/A
TN4S06/L	M4	45/60
TN4S08/L	M5	50/70
TN4S10/L	M6	65/95
TN4S12	M8	80
TN4S14	M10	90



4. RESISTANCES

The maximum tensile load on the indicated materials for an isolated anchor (without spacing and edge distance effects) are specified in the following tables:

4.1. MAXIMUM RECOMENDED LOAD N_{rec} [kg]

TN4S / TN4SA												
Ø PLUG	Ø5		Ø6		Ø8		Ø10		Ø12		Ø14	
Ø SCREW	TPPO Ø3	TPPO Ø4	TPPO Ø4	TPPO Ø5	TPPO Ø4,5	TPPO Ø6	TB Ø6	TB Ø8	TB Ø8	TB Ø10	TB Ø10	TB Ø12
C20/25 Concrete	21	28	32	61	56	170	161	256	150	394	268	628
Solid brick	10	19	25	48	70	104	94	160	62	104	111	224
Hollow brick	19	13	37	39	22	20	30	48	53	54	63	75
12,5 mm Drywall	8	10	13	8	15	6	--	--	--	--	--	--
2 x 12,5 mm Drywall	7	6	7	12	11	17	26	10	--	--	--	--
15 mm Drywall	22	24	28	34	34	36	36	35	--	--	--	--
2 x 15 mm Drywall	17	29	33	39	39	60	76	77	--	--	--	--
AAC2 Aerated concrete	4	4	4	5	7	9	4	9	13	17	--	--
AAC6 Aerated concrete	12	14	21	23	24	59	71	87	47	125	64	135
Ø PLUG	Ø6		Ø8		Ø10		Ø12		Ø14			
THREADED ROD	M4		M5		M6		M8		M10			
C20/25 Concrete	15		27		62		67		89			

TN4S-L						
Ø PLUG	Ø6		Ø8		Ø10	
Ø SCREW	TPPO Ø4	TPPO Ø5	TPPO Ø4,5	TPPO Ø6	TB Ø6	TB Ø8
C20/25 Concrete	12	60	38	129	142	--
Solid brick	20	35	16	68	110	210
Hollow brick	--	39	--	43	--	46
15 mm Drywall	28	34	47	41	--	--
2 x 15 mm Drywall	47	39	51	66	--	--
AAC2 Aerated concrete	4	5	7	9	4	9
AAC6 Aerated concrete	14	28	29	39	71	95

TACON / TACOL / TACOLA

Ø PLUG	Ø4		Ø5		Ø6		Ø7		Ø8		Ø10		Ø12		Ø14		Ø16
Ø SCREW	TPPO Ø3	TPPO Ø3	TPPO Ø4	TPPO Ø4	TPPO Ø5	TPPO Ø5	TPPO Ø4,5	TPPO Ø6	TB Ø6	TB Ø8	TB Ø8	TB Ø10	TB Ø10	TB Ø12	TB Ø14	TB Ø14	
C20/25 Concrete	8	9	20	14	23	15	16	37	85	177	105	244	233	334	352		
Solid brick	5	7	13	9	12	18	49	73	66	112	44	73	77	157	101		
Hollow brick	6	13	9	7	10	12	15	14	21	33	37	38	44	52	59		